

Board Game Storage Rack
with Adjustable Shelves and Wheels

INSTRUCTION MANUAL



Richard
↙

NOBLE MAJESTY!

You've been waiting a while for your Project Adjustable Shelves and Wheels to arrive thank you for your patience, Noble One!

Today is a glorious day! Project Ironside stands ready to serve you in every future gaming session - it just needs a little assembly first...but we're here to help!

Our deepest thanks to every gracious Majesty who has supported and pre-ordered! Over the years, you've helped us take BoxKing Gaming from a flicker of imagination to a small but stalwart gaming company: from project Ironside BoxThrone board game shelves, and LAX RAX, and now Project Kingwood - and many more in the future!

Feel free to tag us on Instagram, YouTube or Facebook once you've built your table! We'll share, retweet, or reply to your post!

Instagram: @BoxKing Gaming

YouTube: @BoxKing Gaming

Facebook: www.facebook.com/BoxKingGaming

You can also see other curious creations at
www.boxkinggaming.com

Onwards, your Majesty - your table awaits!

Humbly yours,

Dan Blacklock and the team at BoxKing Gaming

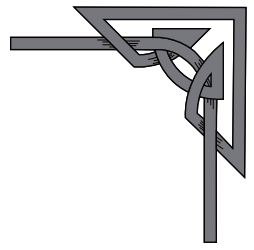
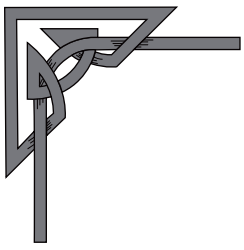





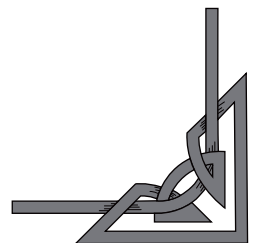
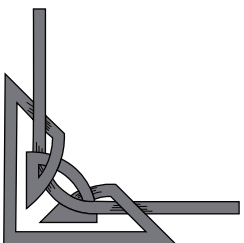

- After unboxing, please check that all screws, brackets, and accessories are complete to avoid missing parts.
- Please follow the instructions carefully. Do not overtighten or forcibly bend metal components to prevent scratches or deformation.
- Place the shelf on a flat, dry surface, avoiding damp (e.g., bathrooms) or high-temperature areas (e.g., near radiators).
- Check every 3 months for loose screws or frame deformation, and tighten or replace them as needed.
- Each shelf layer has a maximum load capacity of 160kg. For game boxes exceeding 5kg, please place them on the lower tiers (1st and 2nd levels). Other tiers should not hold game boxes over 5kg each.
- If the surface gets wet, wipe it dry immediately with a cloth. Do not use steel wool or acidic cleaners to prevent rust or paint damage.
- Avoid placing flammable or explosive items on the shelf.
- Do not allow children to climb on the shelf.
- If you have any questions or comments, please email us at support@boxkinggaming.com

TIPS: Proper use will extend the product's lifespan. Thank you for your purchase!

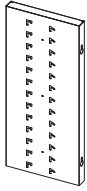
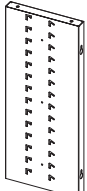
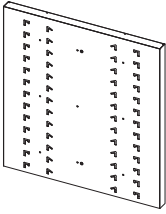
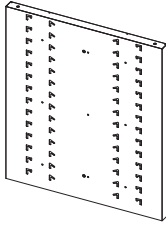
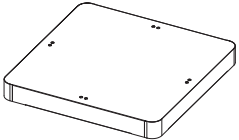
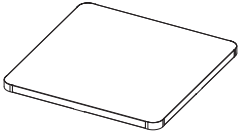

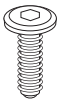
Step 1: Prepare the Components

Required components:

<p>1</p>  <p>Upper Side Panel ×2</p>	<p>2</p>  <p>Lower Side Panel ×2</p>	<p>3</p>  <p>Upper Back Panel ×1</p>	<p>4</p>  <p>Lower Back Panel ×1</p>
<p>5</p>  <p>Base ×1</p>	<p>6</p>  <p>Top Cover Panel ×1</p>	<p>7</p>  <p>Metal Wire Grid ×32</p>	<p>8</p>  <p>Casters ×4</p>
<p>9</p>  <p>M6×30 Screws ×8</p>	<p>10</p>  <p>M6*10 X24</p>	<p>11</p>  <p>Screwdriver ×1</p>	<p>12</p>  <p>Hook x1</p>

Step 2: Install the Casters

- Use the supplied screws and screwdriver to securely fasten the casters to the base.

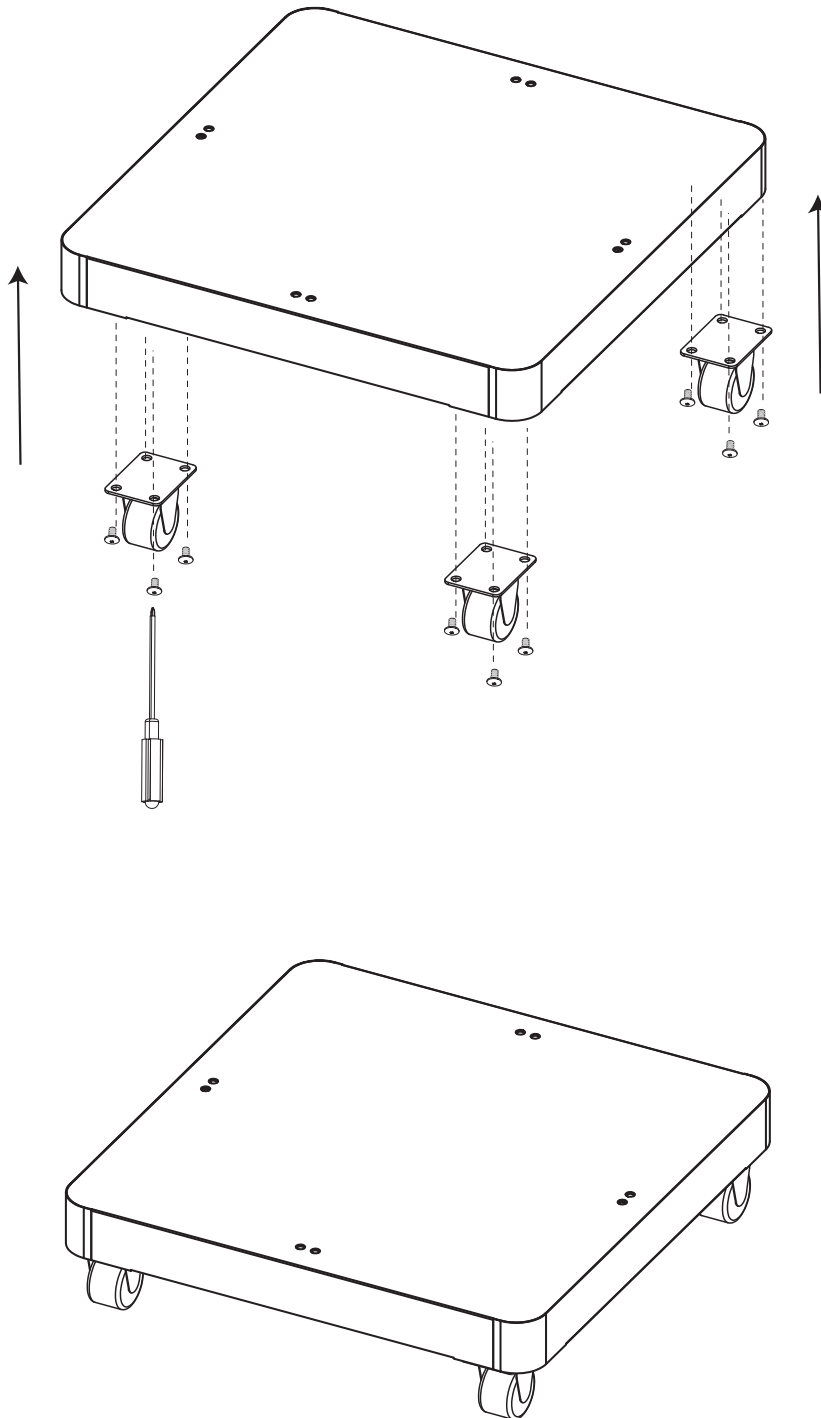



Step 3: Install the Vertical Posts

- Insert the screws into the pre-drilled holes on the panels. Use a screwdriver to tighten the screws and secure the panels together.

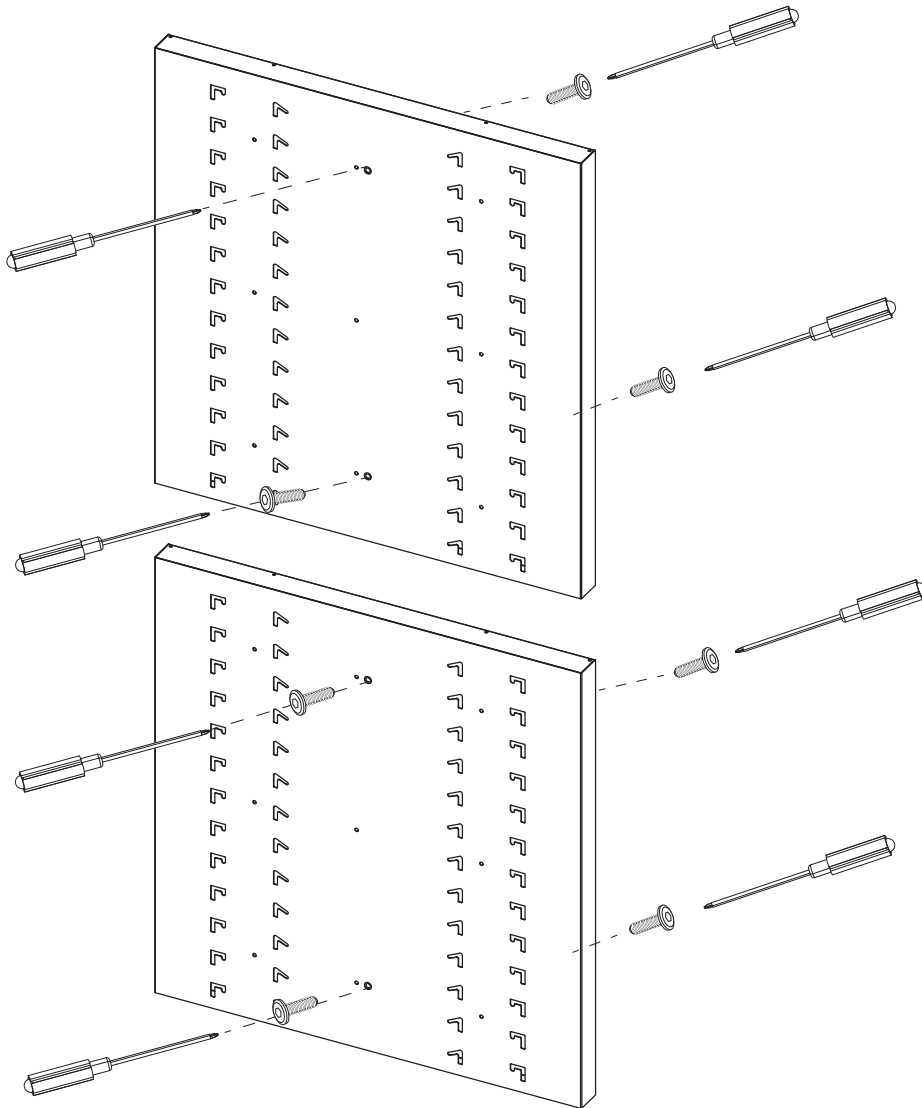

Step 4: Connect the Panels

- Align the holes on the upper panel with the holes on the lower panel, and snap them into place.

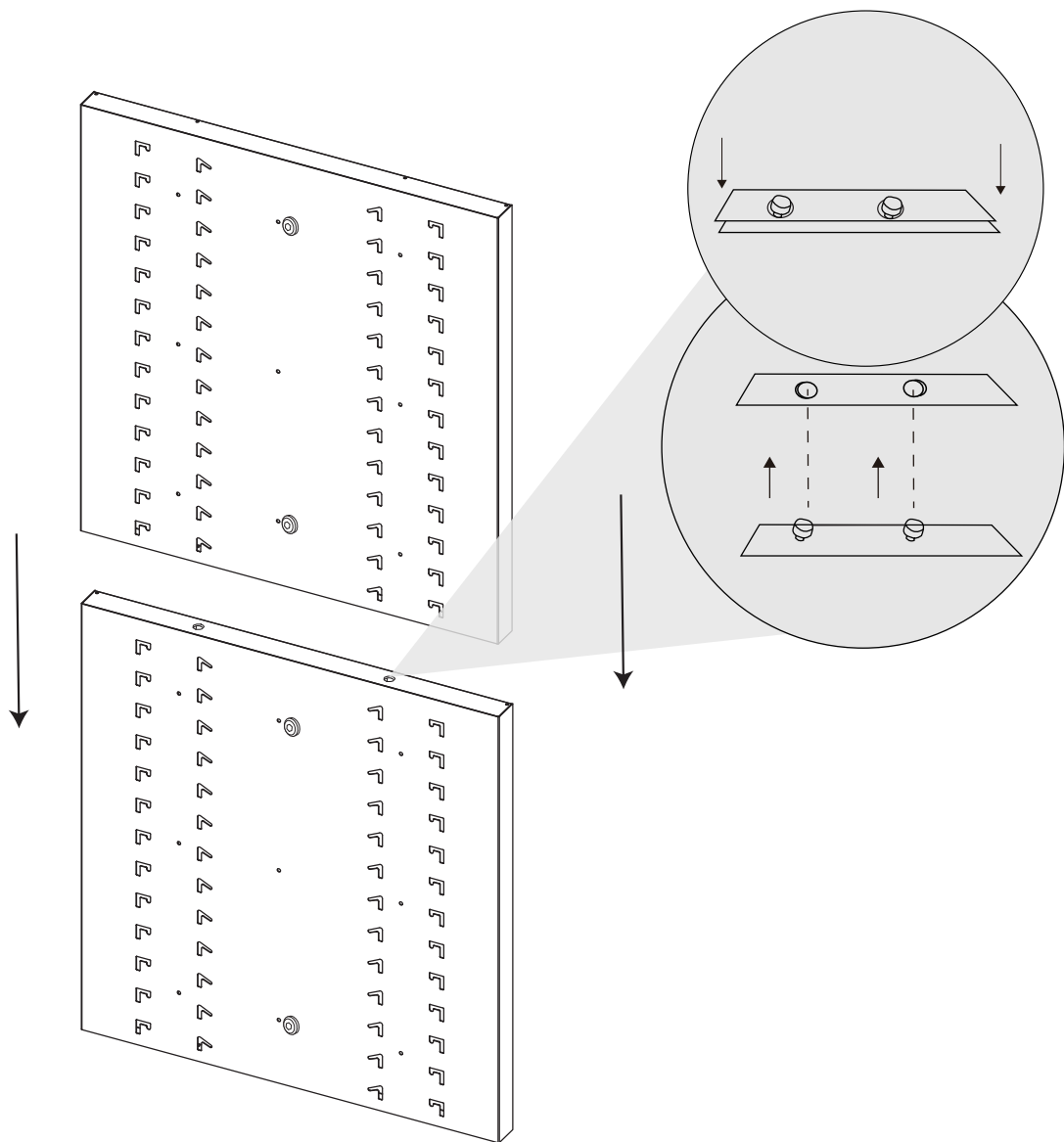



Step 5: Connect the side Panels

- Align the holes on the upper panel with the holes on the lower panel, and snap them into place.

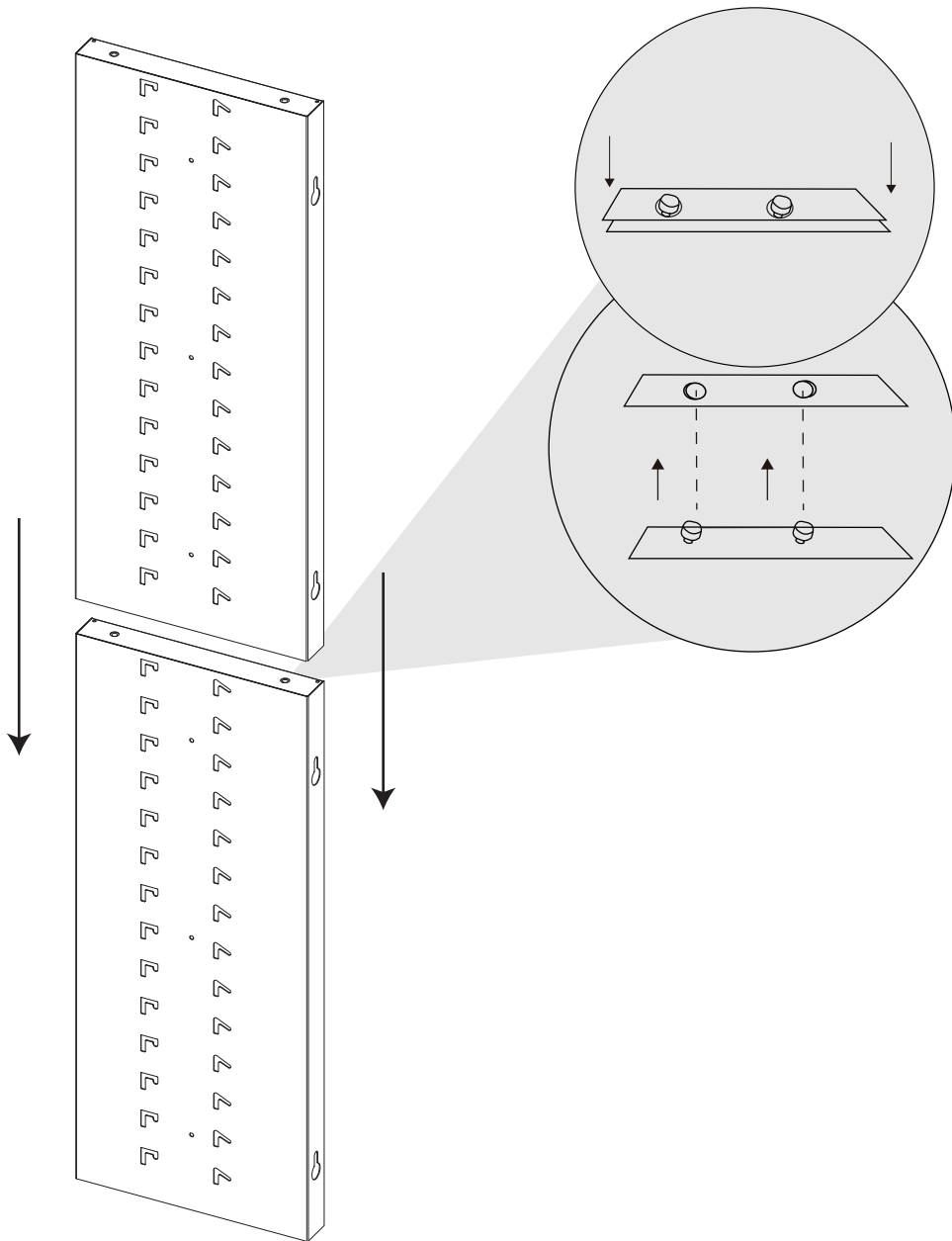

Step 6: Attach the Panel to the Base

- Lower the panels downward following the arrow direction until fully seated. Align the holes underneath the base and tighten the screws from the bottom.

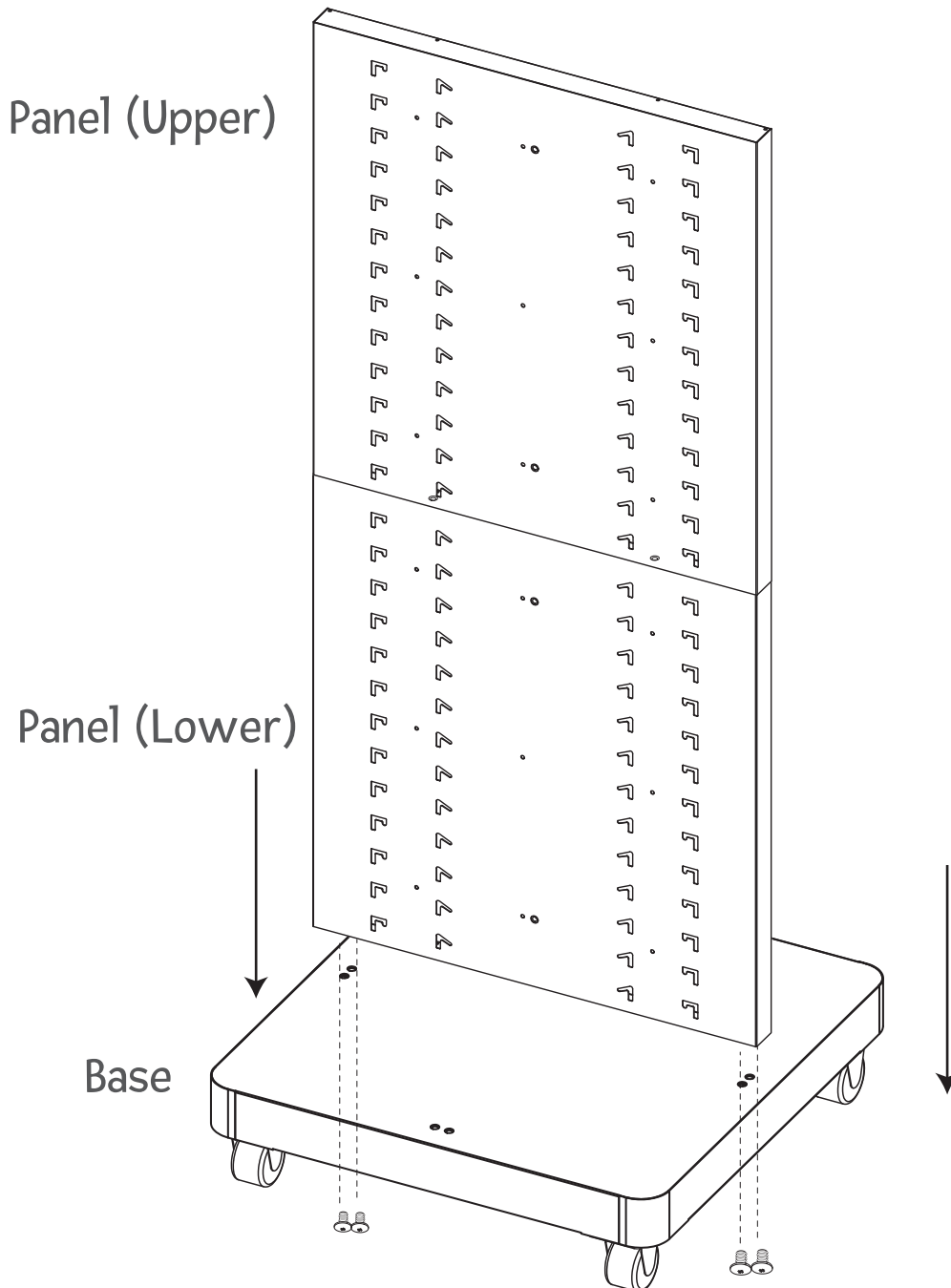

Secure the base with screws



Step 7: Install the Side Panel

- Align the installed side panel with the mounting slots on the main panel following the arrow direction.
Push the side panel inward first, then slide it downward until it is fully engaged in the slots.

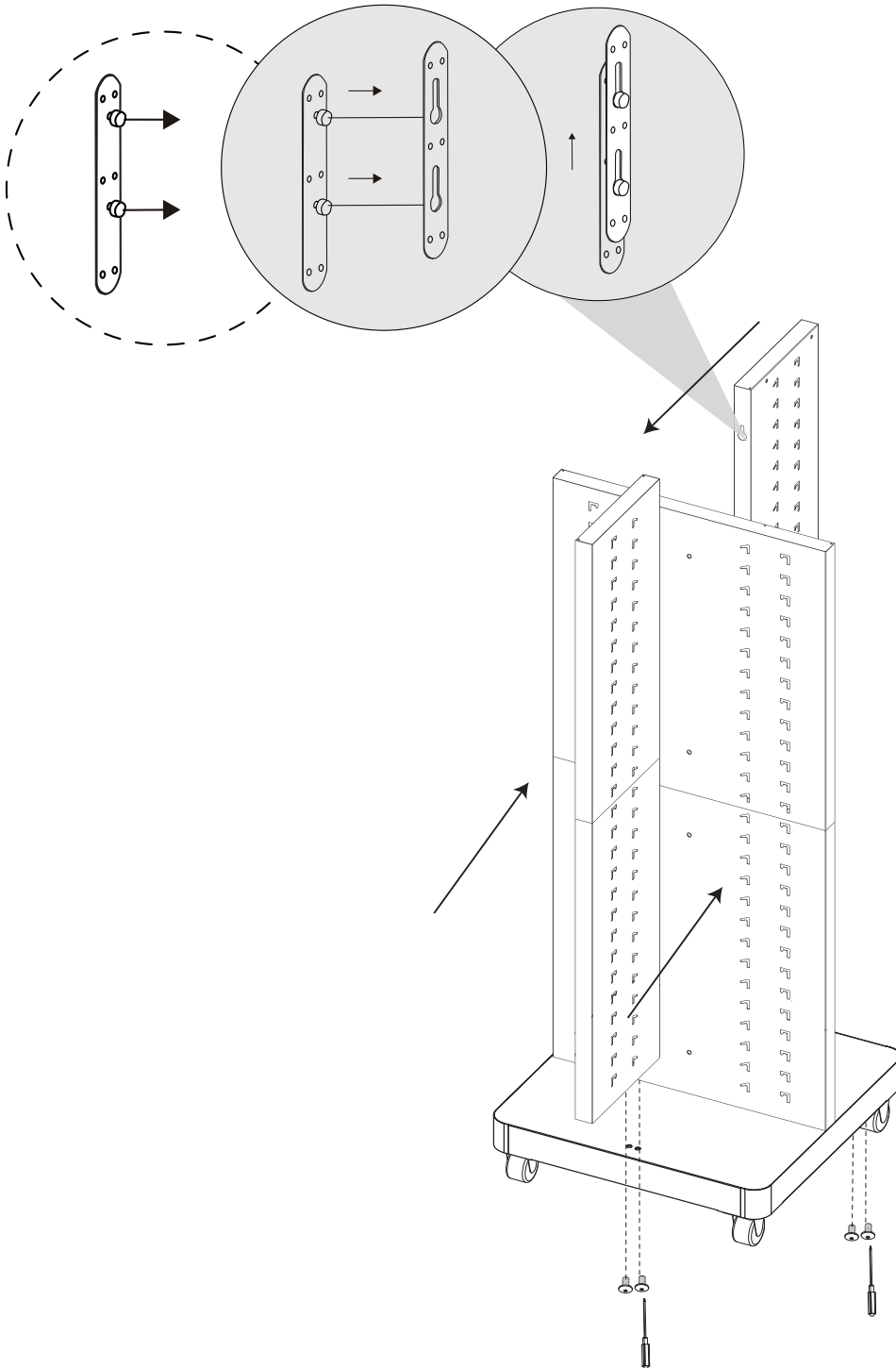

Align the holes at the bottom and secure the panel with screws from underneath the base.

Step 8: Install the Top Cover Panel

- Align the top cover panel with the mounting position on the top of the upright panels.
Lower the top cover panel downward following the arrow direction until it sits flush.

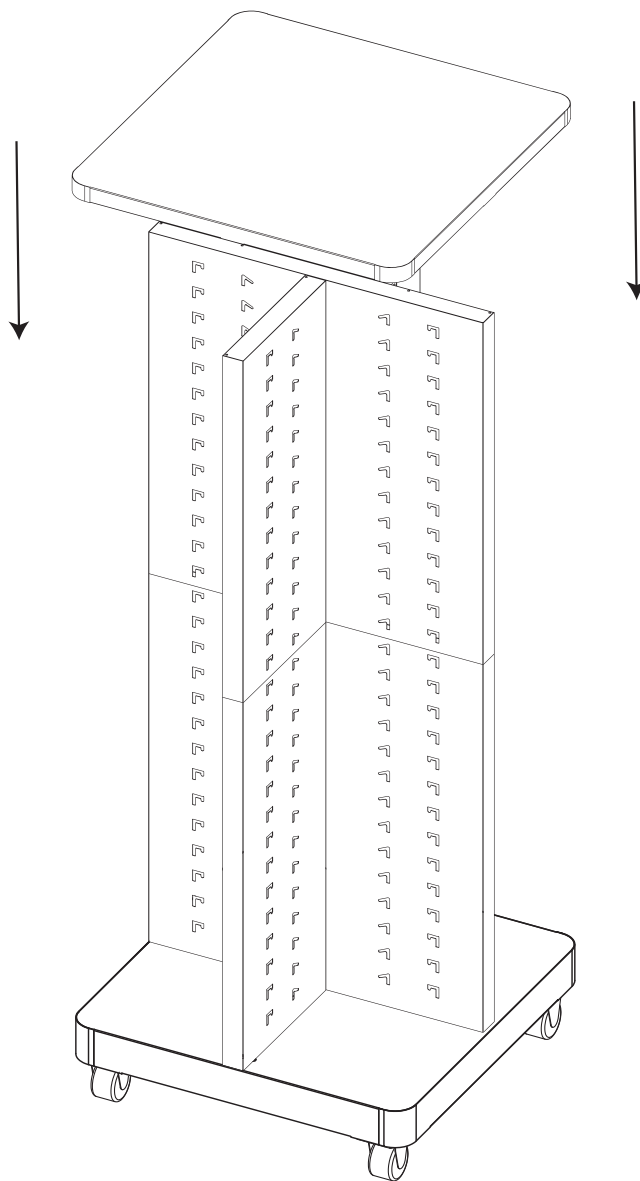



Step 9: Secure the Top Panel

- Align the top panel with the mounting holes on the top of the upright panels.
Use the supplied screws and screwdriver to firmly secure the top panel in place.

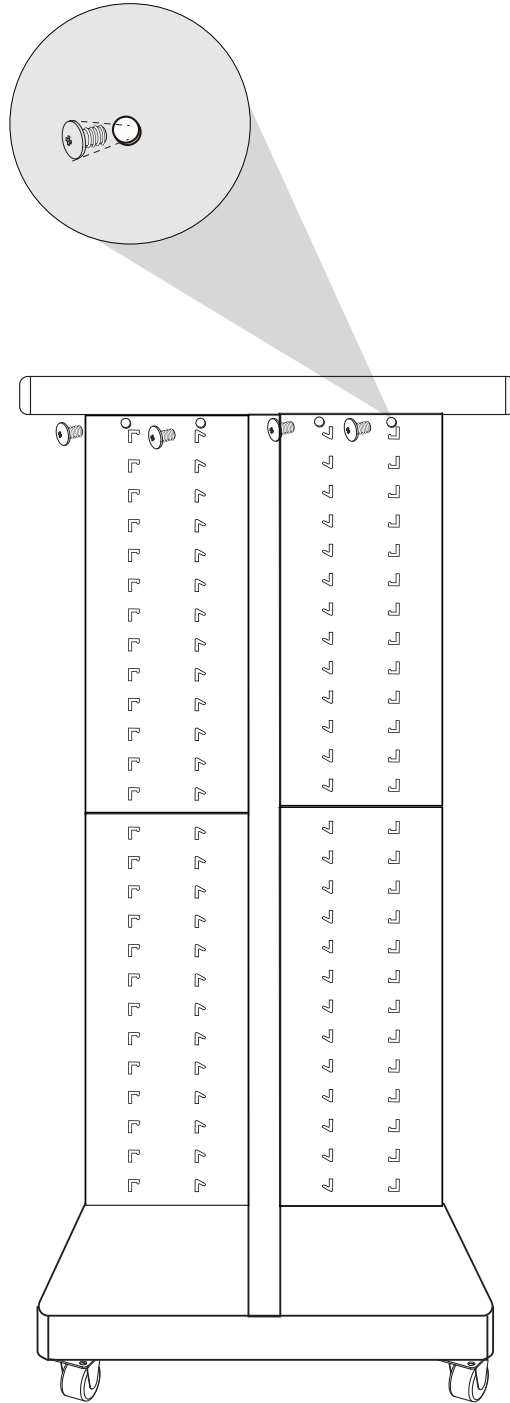

Step 10: Assemble the Metal Rack

- Insert the metal wire grids into the slots on the panels until they are fully seated.

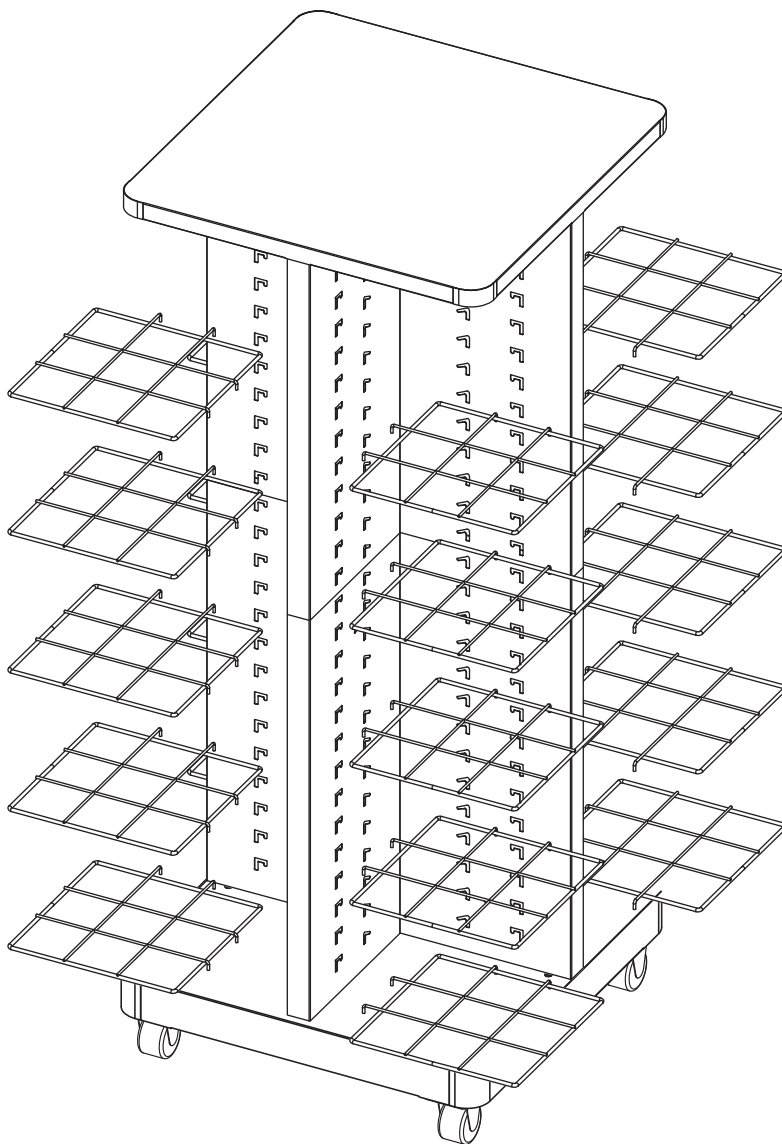



Step 11: Assembly Complete

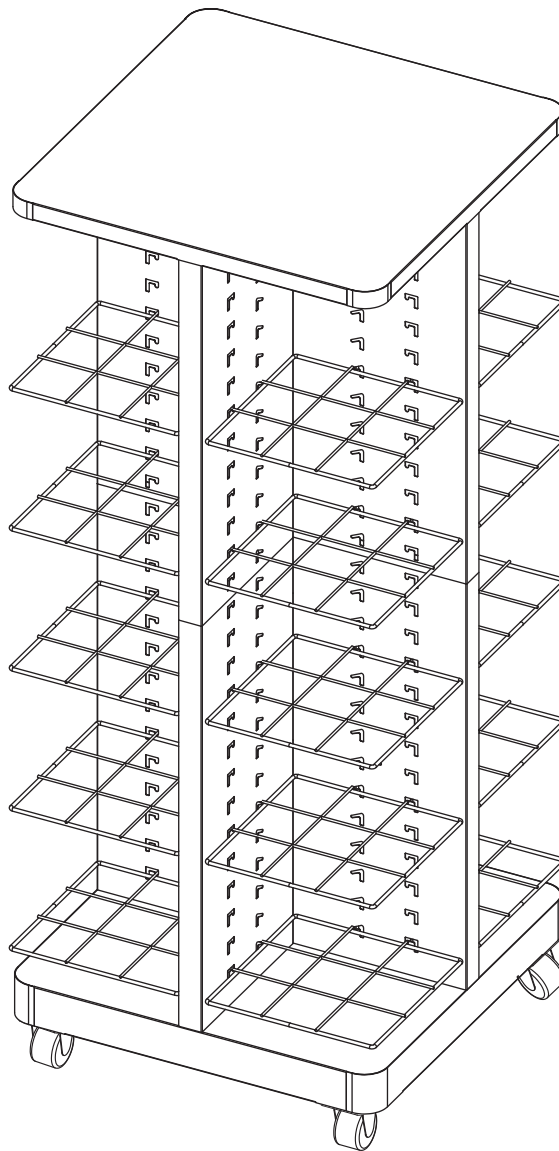

If you have any questions, please contact us at support@boxkinggaming.com.